



Beyondsun Green Energy Installation Manual

For Beyondsun Green Energy Single Glass PV Modules

Version: BS-HANDBOOK-EN-001 Ver: 2311

This general manual provides important safety information relating to the installation, maintenance and handling of single glass solar modules. Professional installer must read these guidelines carefully and strictly follow these instructions. Failure to follow these instructions may result in death, injury or property damage. The installation and handling of PV modules require professional skills and should only be performed by qualified professionals. The installers must inform end-users (consumers) the aforesaid information accordingly.

The word "module" or "PV module" used in this manual refers to one or more double glass solar modules. This manual is only valid for the double glass module types TSP-72, TSP-60, TSP-72H, TSP-60H, TSM-72, TSM-60, TSM-72H, TSM-60H, TSHM-144L, TSHM120L, TSHM-144W, TSHM-132W, TSHM-120W, TSHM-108W, TSHM-96W, TSHM-72W, TSHM-144V, TSHM-132V, TSHM-120V, TSHM-108V, TSHM-96V, TSHM-72V, TSHM-132S, TSHM-120S, TSHM-108S, TSHM-96S, TSHM-72S, TSHM-144HL, TSHM120HL, TSHM-144HW, TSHM-132HW, TSHM-120HW, TSHM-108HW, TSHM-96HW, TSHM-72HW, TSHM-144HV, TSHM-132HV, TSHM-120HV, TSHM-108HV, TSHM-96HV, TSHM-72HV, TSHM-132HS, TSHM-120HS, TSHM-108HS. Please retain this manual for future reference.

We recommend visiting www.beyondsunpv.com regularly for the most updated version of single-glass module installation manual.

1. Safety Warning and Operation Notice



DANGER OF DEATH FROM ELECTRICAL SHOCK!

PV modules can generate electricity upon exposure to light. The voltage of a single module is less than 50 VDC, but the total voltage can be dangerously high when modules are connected together in series. The following must be fully understood and obeyed when handling the PV modules to avoid risk of arcing, fire and electric shock.

- a) Carefully read through these installation instructions before installing, operating or maintaining PV system. Failure to follow these instructions may result in bodily injury or damage to property.
- b) PV systems can produce high voltage and current which could cause serious injury or even death.
- c) The installation of PV modules should only be performed by qualified personnel.
- d) Do not wear metallic jewelry when installing. Do not touch live terminals with bare hands. Use insulated tools for electrical connections.

- e) Do not install PV modules at wet conditions.
- f) Do not use damaged nor defective modules. Even damage or defective modules can produce electricity. Keep damaged or defective modules covered to avoid exposure to light.
- g) Contact with electrically active parts of a PV module such as terminals, can result in burns sparks and lethal shock whenever the PV modules are connected or not.
- h) Use appropriate safety equipment when working on any wiring.
- i) Never disassemble nor break any part of the PV module, including nameplate.
- j) Keep children and other unqualified people away from the PV system.



DANGER OF DEATH FROM ARCING!

- a) PV modules generate current under sunlight. A lethally strong arc may occur when breaking a connected module or a string of modules. Operation should be performed only by professional engineers equipped with professional tools.
- b) Never disconnect the PV module from the inverter when the inverter is still connected to the main grid, but remove the fuse from the AC side on the inverter before operation.
- c) Ensure cable and connectors are at perfect condition (no splitting, soiling, nor contamination).
- d) One should never touch the wet connectors, without using personal protective equipment or wearing insulating gloves.

1.1 General Safety

- a) All PV modules installation should be in accordance with applicable international and related local laws, codes and regulations.
- b) Artificial sunlight should not be concentrated upon the PV modules. Do not expose PV modules to sunlight concentrated with mirrors, lens or other means.
- c) The PV modules are rated as application class A. Modules rated for use in this application class may be used in systems operating at greater than 50V DC or 240W, where general contact access is anticipated. Modules qualified for safety through IEC 61730-1 and this part of IEC 61730 within this application class are considered to meet the requirements for safety class II.
- d) Under normal conditions, a photovoltaic module is likely to experience conditions that produce more current and/or voltage than reported at standard test conditions. Accordingly, the values of I_{sc} and V_{oc} marked on this module should be multiplied by a factor of 1.25 when determining component voltage ratings, conductor

capacities, fuse sizes, and size of controls connected to the PV output.

- e) Only PV modules with the same cell type and size may be connected in series.
- f) Avoid any shade on the PV module surface. Shaded cells may become hot (hotspot phenomenon) resulting in permanent damage to the module or even fire hazard.
- g) Follow safety precautions of all other components used in the PV system.

1.2 Handling Safety

- a) Follow the unpacking instruction. Carry the module by at least two persons. Do not lay nor pile the PV module casually. Avoid any objects stacking or falling on the PV modules.
- b) Do not stand nor step on the PV module. The glass may be slippery, and there is a risk of injury or electric shock if glass is broken.
- c) Please handle PV modules with care, avoiding any bump or drop.
- d) Do not expose the PV module to excessive loads on the surface of the PV module nor twist the frame, otherwise, the glass and solar cells may break.
- e) Do not draw the cable of J-box excessively during installation. The cables should be in a relaxed state after connection.
- f) Do not touch the PV module with bare hands. The frame of the PV module has sharp edges and may cause injury.
- g) Wear suitable gloves, such as leather gloves with padding in the palm and finger areas.

1.3 Installation Safety

- a) Always wear protective helmet, insulating gloves and safety shoes (with rubber soles).
- b) Due to risk of electrical shock, never perform work when PV modules are wet.
- c) Do not install PV modules at rainy, snowy or windy conditions.
- d) Ensure the connectors are fully and correctly connected. Connectors and cables should be fixed to the PV module frames, support structure or raceway to prevent movement. Keep connectors out of direct sunlight or water immersion.
- e) Do not touch the J-box and the end of the cables with bare hands during installation, regardless of whether the PV module is connected to the system or not.
- f) Do not unplug connectors if the system circuit has been connected to an operating load.
- g) When installing PV modules on roofs or other structures, appropriate safety practices and safety equipment should always be used to avoid injury.

1.4 Fire Safety

- a) The PV modules should never be installed near inflammable gas, hazardous chemicals or fire source.
- b) The PV modules have been rated as Fire Class C (unless specified). For roof PV project, the PV modules are to be mounted over a fire-resistant roof.
- c) There should be lightning protection devices in the PV system. The maximum fuse rating is 20A.

2. Mounting

2.1 Location Selection and Environment

- a) Do not install the PV module where could be flooded or immersed.
- b) Do not install the PV module in a flammable gas environment (such as gas station, storage tank etc.) nor near fire source.
- c) Temperature endurance range of the PV module is $-40^{\circ}\text{C} \sim 85^{\circ}\text{C}$, while the environmental temperature range of $-20^{\circ}\text{C} \sim 45^{\circ}\text{C}$ is recommended for module installation.
- d) Unless specified, the maximum bearing load of PV module is 5400Pa for front side, and 2400Pa for backside. The natural environment condition should be fully considered to not to exceed the maximum pressure. The accumulated snow should be removed in time to prevent causing any damage to the PV modules.
- e) The PV module should not be installed in the environment of excessive salt fog, hail, sand and dust, smoke, active chemical atmosphere, acid rain etc.
- f) The PV module should be installed at least 200m away from the sea side. Corresponding measure should be adopted to avoid module corrosion and grounding failure for the distance of 200m~1000m away from sea side. Installation of 1km away from sea side is recommended.

2.2 General Installation

- a) Condition of site should be fully investigated to ensure it is suitable for PV system. The installation should be designed by qualified engineer, conforming to all relevant construction/electrical laws, regulations and codes. PV installation should be approved by relevant authorities.
- b) The PV module should be mounted on supporting structures. Other components of the PV system should not have any undesirable mechanical or electrical influence on the PV module.
- c) Bearing ability of the supporting structure should be enough to sustain the modules weight and wind/snow pressure, as well as the pressure from installers and apparatus. Design of supporting structure should guarantee that there will be no effect on the modules when hot swell happens.
- d) The PV module should be firmly fixed with bolts or clamps on the supporting structure. The interval between

modules should be at least 10mm.

- e) Do not cause any damage of the PV modules during mounting. Do not drill holes on the frame. Otherwise, the warranty is not valid any more.
- f) Bending radius of the J-box cable should be more than 60mm.
- g) Module installation site should maintain good ventilation to facilitate the heat dissipation, which is in favor of the power generation and fire safety.
- h) For PV installation on the ground, the modules are expected to be at least one meter high from the ground to avoid soil, grass and snow covering the bottom part of the modules.
- i) For PV installation on the rooftop, the structure and bearing ability of roof must be suitable. The fastness of installation should be guaranteed to avoid the module falling off from rooftop. There should be a gap of at least 5cm between the module and roof.



CAUTION!

Roof structure will affect the fireproofing so it's necessary to earth ground fault circuit breaker. Unsuitable installation will bring on extra damages! When installing the module on a roof or building, do so in calm winds. Installing a module during strong winds may cause accidents!

- j) For the project on water surface, installation conditions should be provided in advance, so that the module manufacturer can choose the suitable materials to be in accord with the water surface installation conditions.

2.3 Installation Methods

- a) PV modules can be mounted to the substructure by screwing (Example A) at the back side.

Example A: Clamping

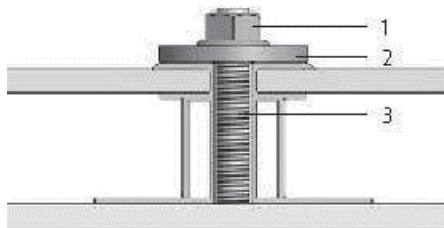

Example B: Bolting

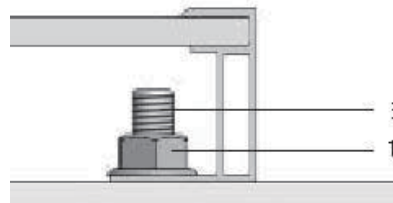

- 1) Stainless steel lock nut
- 2) Stainless steel washer
- 3) Stainless steel M6/ M8 bolt

- b) Clamp fixing: Torque wrench is recommended for installation. The tightening torque (using stainless steel M6/ M8 bolts, stainless steel washer and stainless steel M6/ M8 nut) should be around 15-20Nm)

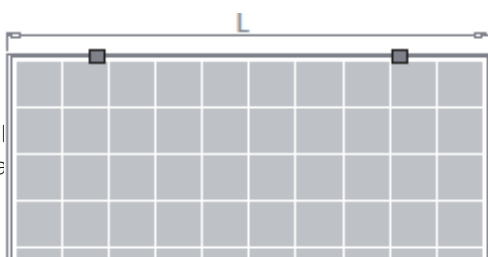

Front and back side 2400 Pa: $L/8 \leq e \leq L/4$, $a \geq 6cm$

- c) Clamp fixing: Torque wrench is recommended for installation. The tightening torque (using stainless steel M6/ M8 bolts, stainless steel washer and stainless steel M6/ M8 nut) should be around 15-20Nm.

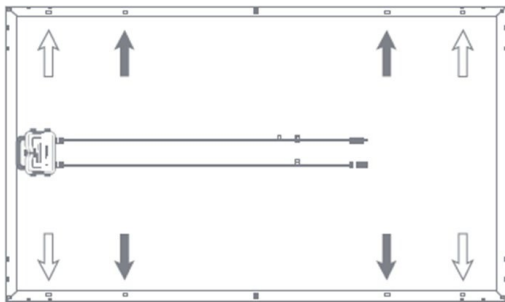

3. Electrical Installation

3.1 Cables and Wiring

Correct wiring scheme

When designing the system, avoid forming loops (to minimize risk in the event of an indirect lightning strike). Check that wiring is correct before starting up the generator. If the measured open circuit voltage (Voc) and short-circuit current (Isc) differ from the specifications, then there is a wiring fault.

- Use field wiring with suitable cross-sectional areas that are approved for use at the maximum short-circuit current of the PV module. Installer use only sunlight resistant cables qualified for direct current (DC) wiring in PV systems. The minimum wire size should be $4mm^2$ and temperature rating is at $-40^{\circ}C$ to $+85^{\circ}C$.
- Each module string should be equipped with fuse protector.

Cable standard	Test standard	Cable Size	Temperature Rating
	EN50618	$\geq 4mm^2$	$-40^{\circ}C$ to $+85^{\circ}C$

- Correct connection of contact plug connectors. The plug connector has its own polarity. The terminals marked with "+" and "-" represent the positive and negative terminals of the power supply. Only those terminals indicated with

"+" and "-" should be connected to the load. Make sure that the connection is safe and tight.

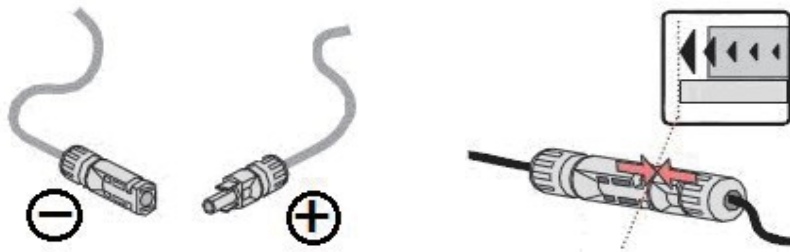

- d) Under normal conditions, a Module may produce more current and/or voltage than reported at standard test conditions. Accordingly, the values of ISC and VOC marked on the Module should be multiplied by a factor of 1.25 when determining component voltage ratings, current ratings, fuse sizes, and size of controls connected to the PV output.
- e) To ensure proper system operation the correct cable connection polarity (Figures A & B) should be observed when connecting the modules to each other or to a load, such as inverter, a battery etc. If modules were not connected correctly, the bypass diode could be destroyed. PV modules can be wired in series to increase voltage. A series connection is made when the wire from the positive terminal of one module is connected to the negative terminal of the next module. Figure A shows modules connected in series. PV modules can be connected in parallel to increase current (Figure B). A parallel connection is made when the wire from the positive terminal of one module is connected to the positive terminal on the next module.

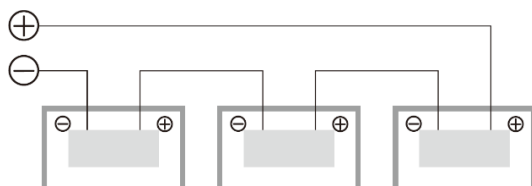

Figure A connection in series

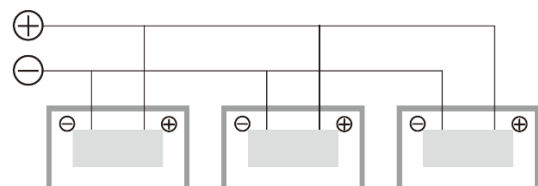

Figure B: connection in parallels

- k) The number of modules in series shall be calculated reasonably according to the system configuration and corresponding rules. The open circuit voltage under the condition of local minimum temperatures expected value cannot exceed the maximum module system voltage (according to IEC61730, the maximum system voltage of TRUNSUN's module are 1000 V and 1500 V, the client may calculate according to the actual voltage of module) and the required value of the other DC electrical components.

The maximum number of the modules can be installed in a string can be calculated based on below formula: $N = V_{max} / V_{oc}(1 - \beta(25 - X))$.

Voc: Open circuit voltage of each module (refer to product label or data sheet)

Vmax: Maximum system voltage

B: Thermal coefficient of open circuit voltage for the module (refer to data sheet)

X: The lowest expected ambient temperature for the installation location

N: The maximum number of modules in series



CAUTION!

Connectors provided by different suppliers will not mutual match up. Different connectors provided by one supplier will not match up either. Only one type of the same connector from one supplier shall be used to ensure the reliability of electrical connection. The plug connector should not receive outer stress. Otherwise, it is only used to connect the circuit!

3.2 Grounding

- a) Grounding PV modules is necessary to reduce or eliminate shock and fire hazards. The installer of a PV system is responsible for grounding each module frame. It is recommended to ground each module frame at the provided grounding holes (4 mm or 5/32 inch diameter, marked with the grounding symbol).

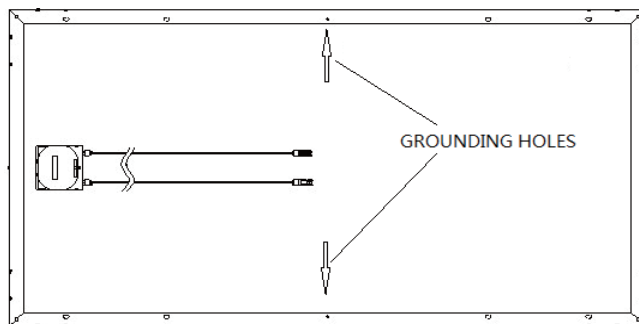

- b) PV module frame is made of anodized aluminum. Corrosion can occur if PV module is subject to a salt-mist environment and is in contact with another type of metal (electrolytic corrosion). If condition permits, PVC washers may be placed between PV module frame and support structure to prevent this type of corrosion. All bolts, nuts, washers for grounding should be made of stainless steel, unless otherwise specified.

3.3 Electrical Configuration

PV modules connected in series should have similar current, and modules must not be connected together to create a voltage higher than the permitted system voltage. The maximum number of modules in series depends on system design, the type of inverter used and environmental conditions.

4. Cleaning and Maintenance

4.1 Cleaning

The amount of electricity generated by a solar module is proportional to the amount of light falling on it. A module with shaded cells will produce less energy and therefore it is important to keep modules clean. Appropriate maintenance

measures shall be taken to keep the assembly free of snow, guano, seeds, pollen, leaves, branches, dust and stains, etc.

- a) Do not change the PV components optionally (diode, junction box, plug connectors).
- b) In most conditions, the normal rainwater can keep the module glass clean. Clean the glass surfaces with wet soft sponge or cloth if necessary. Use mild non-abrasive cleaning agent to remove stubborn dirt. If the module installation Angle with the ground is 0 °, it required relatively frequent cleaning frequency. In general, if installation Angle is 15 °, the module's self-cleaning ability is better than 0 °.
- c) Do not use high pressure water spray nor chemicals to clean the PV modules.
- d) When cleaning PV modules, do NOT step on the modules; do NOT spray water on the backside of the module or the cables; do NOT clean the backside of the modules; keep the connectors clean and dry; prevent fire and electrical shock from occurring; do NOT use as steam cleaner.
- e) Modules can work effectively without cleaning, but removing dust from the glass surface can increase output power. Use a wet sponge or cloth to clean the surface of the glass. Wear rubber gloves for maintenance.
- f) The back surface of the module normally does not need to be cleaned but, in the event this is deemed necessary, avoid the use of any sharp projects that might damage the penetrating the substrate material.

4.2 Maintenance

- a) All fastenings should be kept tight and secured free of corrosion. It is recommended to perform a preventive inspection every six months without changing the components of the module. If electrical or mechanical properties are required for inspection or maintenance, qualified professionals should be advised to avoid any electric shock or loss of life.
- b) Inspect for loose or corroded electrical interfaces, loose connections between supports and components, connections between cables, connectors, and grounding. Check the grounding resistivity routinely.
- c) Replacement modules must be of same type. Do NOT touch live parts of cables and connectors. Use appropriate safety equipment (insulated tools, insulating gloves, etc.) when handling modules.
- d) All fastenings should be kept tight and secured free of corrosion. All cable connections should be secure, tight, clean and free of corrosion. Cables should be kept intact.
- e) PV module should not be discarded casually, but should be recycled by professional organization.
- f) Trim any vegetation which may shade the solar array, thus impacting performance.

5. Disclaimer

- a) Beyondsun Green Energy gives no warranty of any kind whatsoever, either explicitly or implicitly, with respect to the information contained herein.
- b) Beyondsun Green Energy have rights of modifying manual, PV products, specifications or the rights of the product

information, without prior notice.

- c) This manual information based on reliable our knowledge and experience, including product specifications of the information and advice does not constitute any guarantee.
- d) Do not dispose of electrical appliances as unsorted municipal waste, use separate collection facilities. Contact your local government for information regarding the collection systems available. If electrical appliances are disposed of in landfills or dumps, hazardous substances can leak into the groundwater and get into the food chain, damaging your health and well-being. When replacing old appliances with new ones, the retailer is legally obligated to take back your old appliance for disposals at least free of charge.

Zhejiang Beyondsun Green Energy Technology Co., Ltd.

Add: No.888 Zhili Section of G318 Zhili Town, Huzhou City, Zhejiang Province, China

Tel: +86 572 255 2155

E-mail: info@beyondsunpv.com

Web: www.beyondsunpv.com